



Werkzeug - Mittelpunkt

Firma: MERATH metallsysteme GmbH

Maschine: TruPunch 5000, TRUMATIC 5000 ROTATION

Werkzeugnummer: 73X118-164

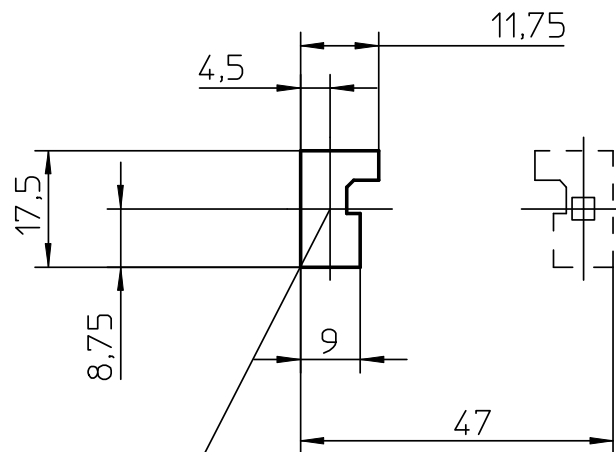

Werkzeug - Mittelpunkt